

PARTICOLARE NODI: 33

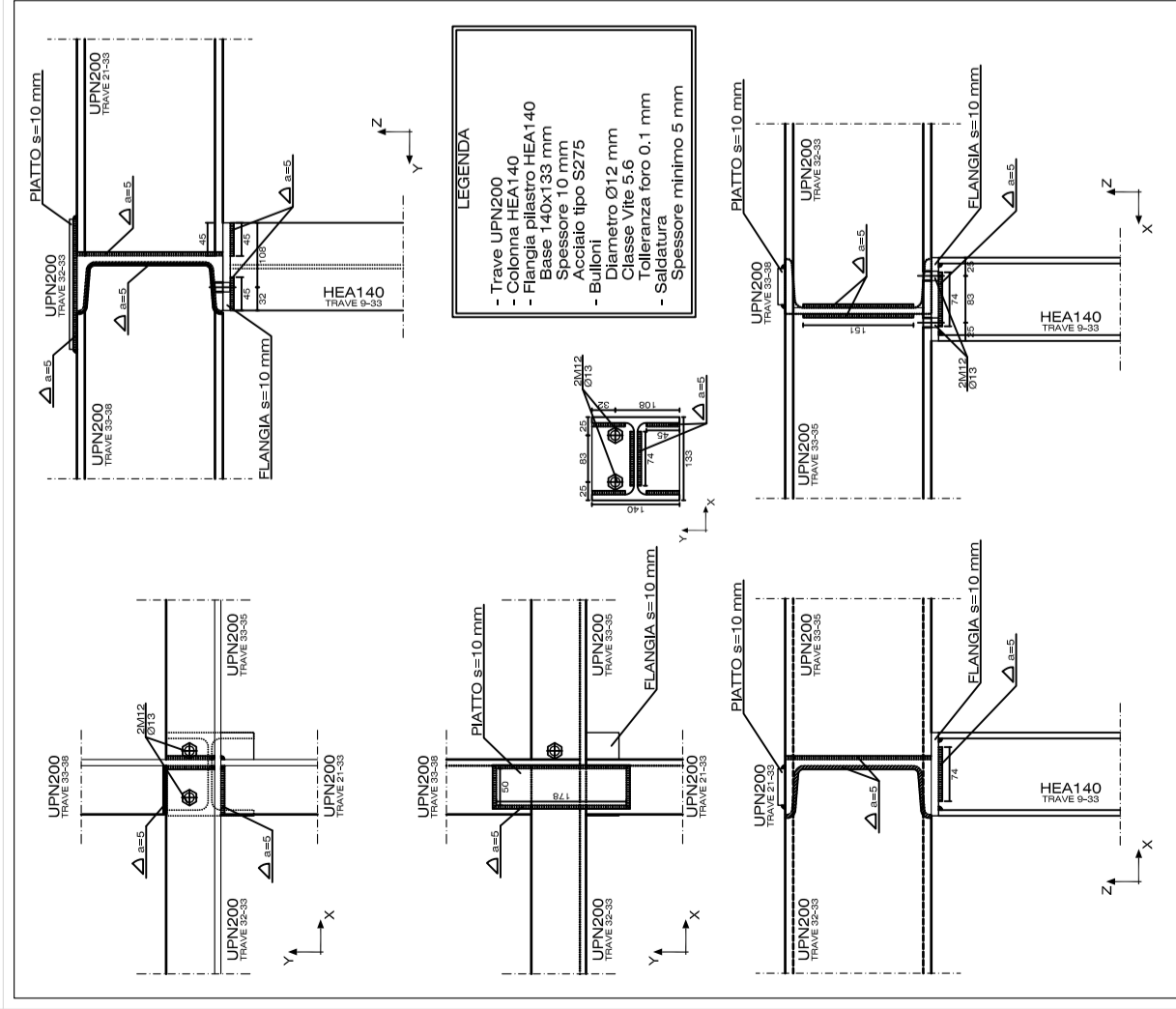

PARTICOLARE NODI: 41

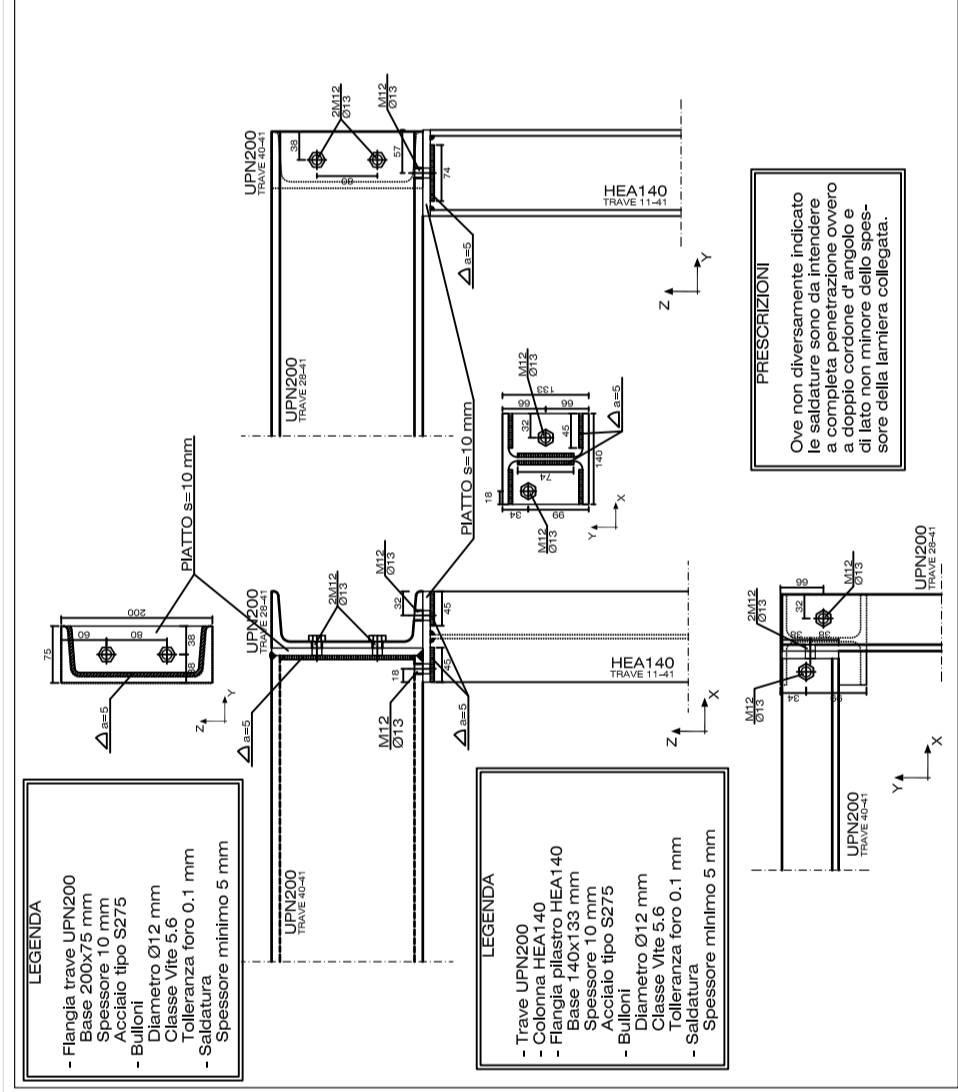

PARTICOLARE NODI: 19 - 43

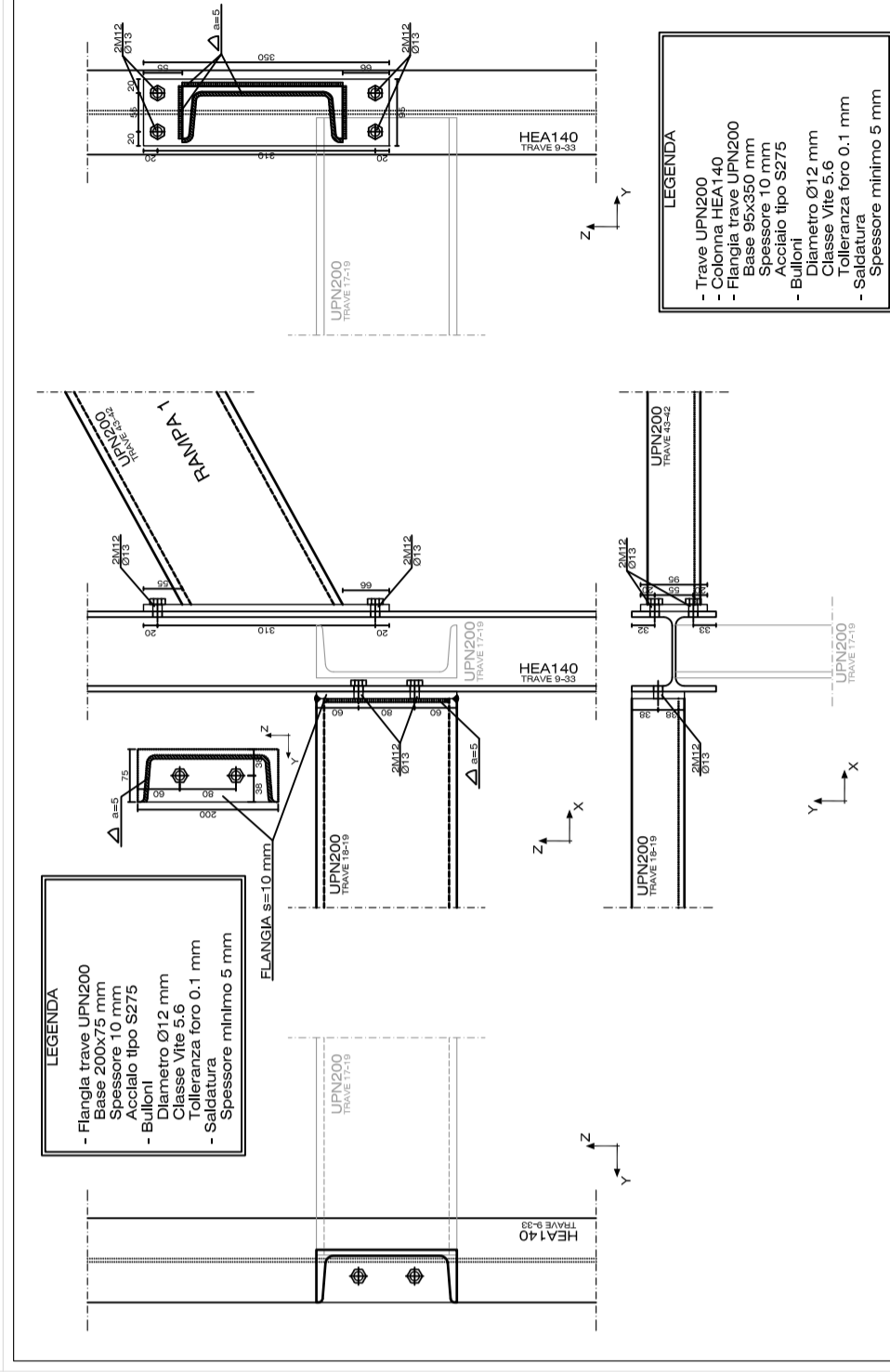

PARTICOLARE NODI: 35

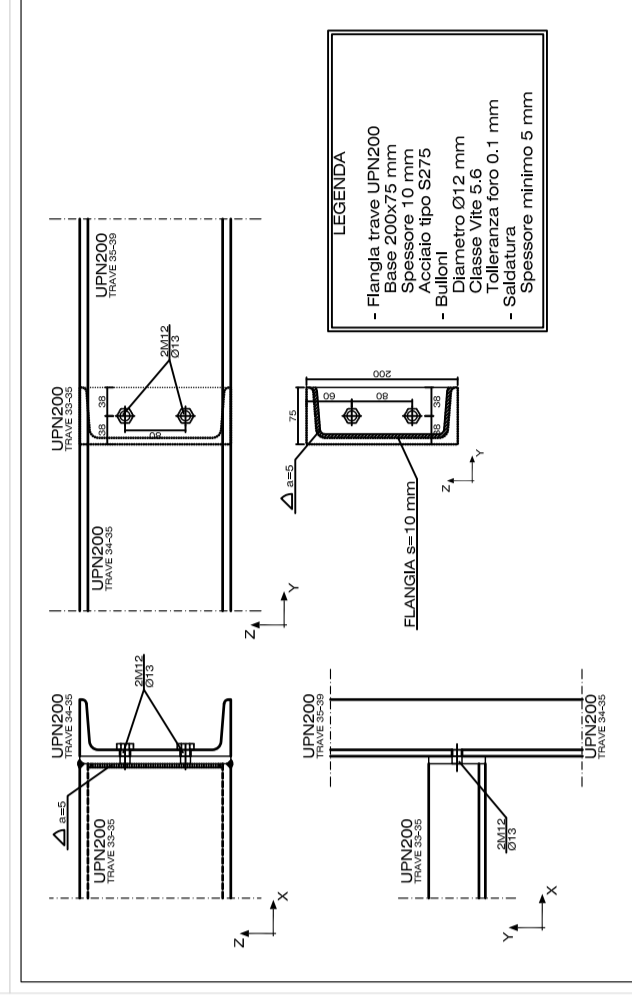

PARTICOLARE NODI: 40 - 42

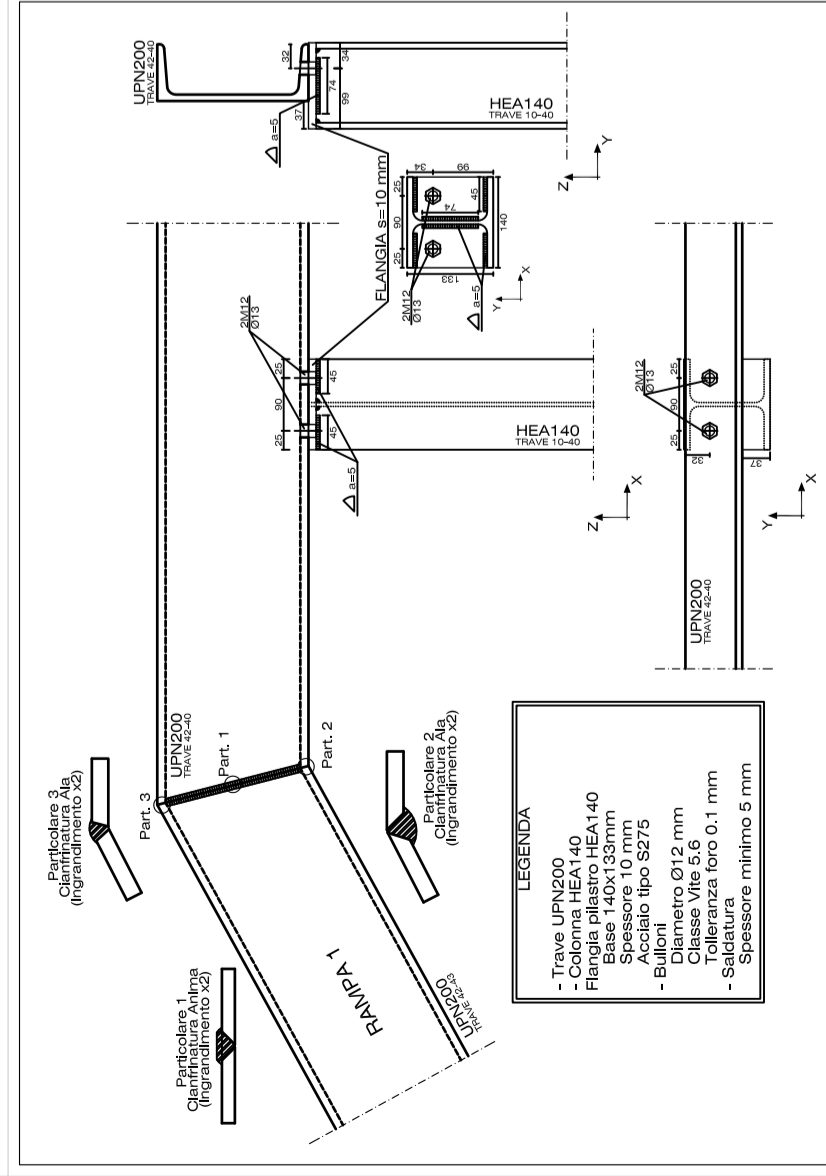

PARTICOLARE NODI: 32

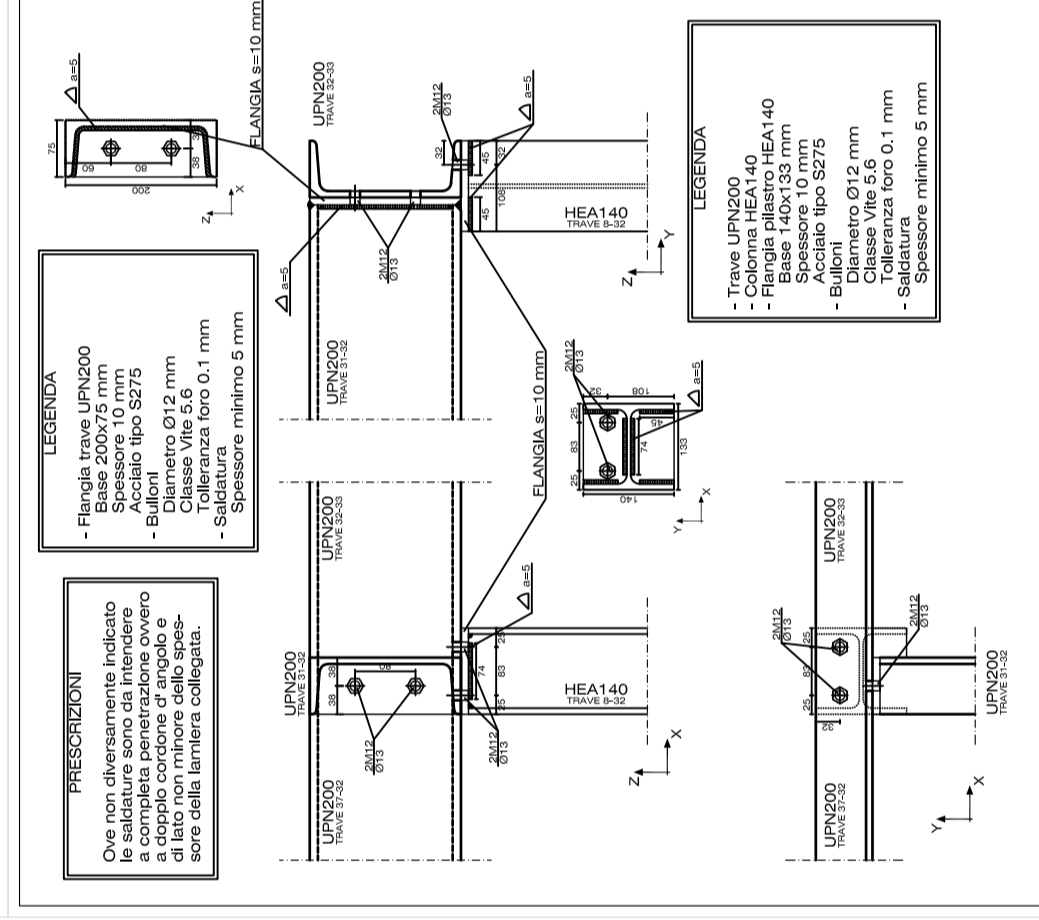

PARTICOLARE NODI: 18

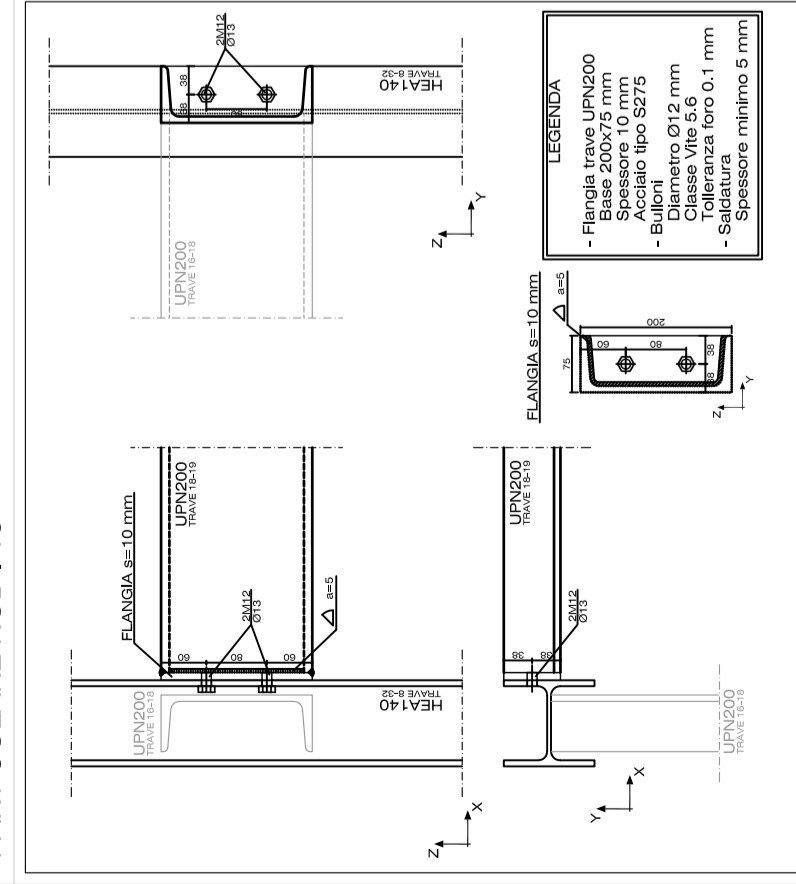

PARTICOLARE NODI: 18 - 43 - 32 - 33

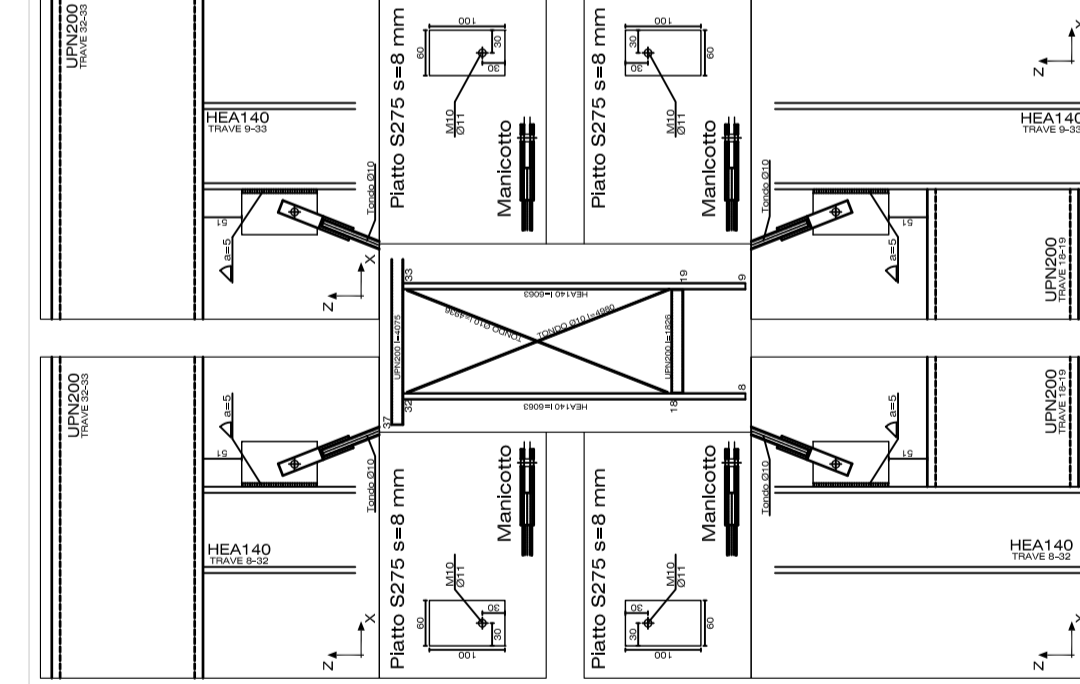

PARTICOLARE NODI: 10 - 11 - 40 - 41

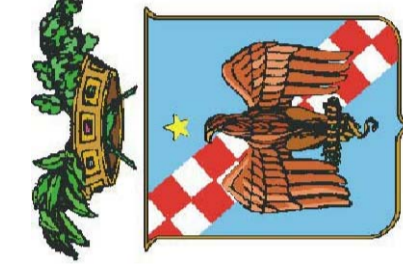
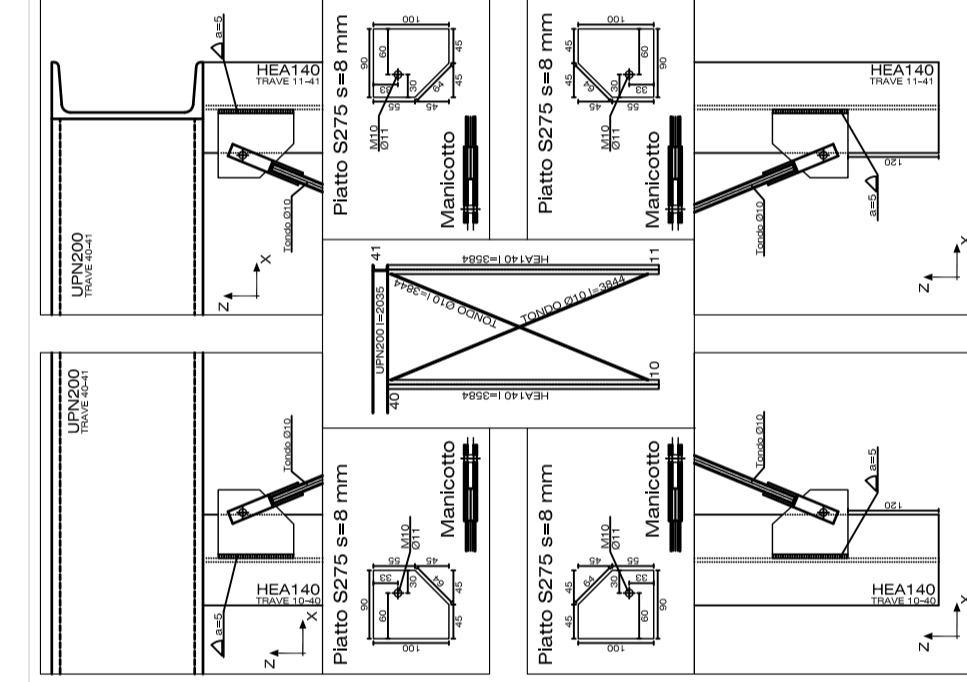

## Provincia Regionale di Ragusa

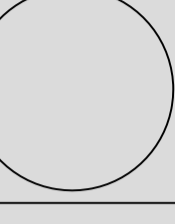

Lavori di  
"Adeguamento alle norme di  
sicurezza e prevenzione incendi  
immobili scolastici nella zona di  
Ragusa, Comiso e Vittoria.  
Completamento € 2.000.000"

- Progetto Esecutivo -

Aggiornato ai sensi dei disposti del comma A  
dell'art.10 della L.R. 12.07.2011 n.12

### progettisti:

**Ing. Francesco Minardi**

via g.b.odierna, n.118  
97100 Ragusa  
p.iva 00939750881  
c.f.: MNRFC65A20H163G  
tel.: 0932.626760  
fax: 0932.1733032  
e-mail: ing.minardi@gmail.com

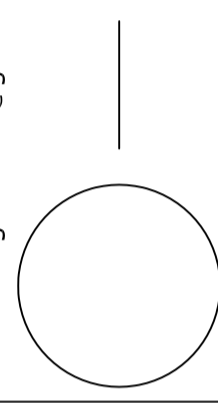

**Ing. Marco La Rosa**

viale dei platani n.34b  
97100 Ragusa  
p.iva: 01205490889  
c.f.: LRS MRC 73E19 H163W  
tel/fax: 0932.643093  
e-mail: inglarosam@tin.it

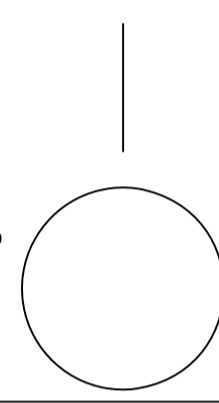

Istituto Magistrale  
"G. Mazzini"  
via Curtatone, Vittoria (RG)

## Tav D8c

Oggetto:  
Scala di emergenza  
esterna in acciaio -

TELAIO 3  
Particolari dei nodi

Rev: n.2 Luglio 2011  
data: Aprile 2010  
scala - 1:10

